

4096-630
February 03, 2021

ASSEMBLY MANUAL
Revision K

1.2M Ku-BAND Rx/Tx SERIES 1132 ANTENNA SYSTEM



SATCOM & Antenna Technologies, Inc.
1700 Cable Drive NE
Conover, NC 28613 USA
t +1 704-462-7330
f +1 704-462-7380

**1.2M Ku-BAND Rx/Tx
SERIES 1132 ANTENNA SYSTEM**

K	Updated to CPI format.	02/03/21	R.F.
J	Revise text	7/23/19	RAH
I	Revise to Conover Address	4/19/16	RAH
H	General Revision	5-29-07	RAH
F	Del 0185-492 add 0185-491	12/16/04	RAH
E	Revised Az/EI to 0185-492	10/12/04	RAH
D	Revised for new reflector	9/3/2003	CLT
-	ORIGINAL RELEASE	3/14/01	CLT
REV.	DESCRIPTION	DATE	APPROVED

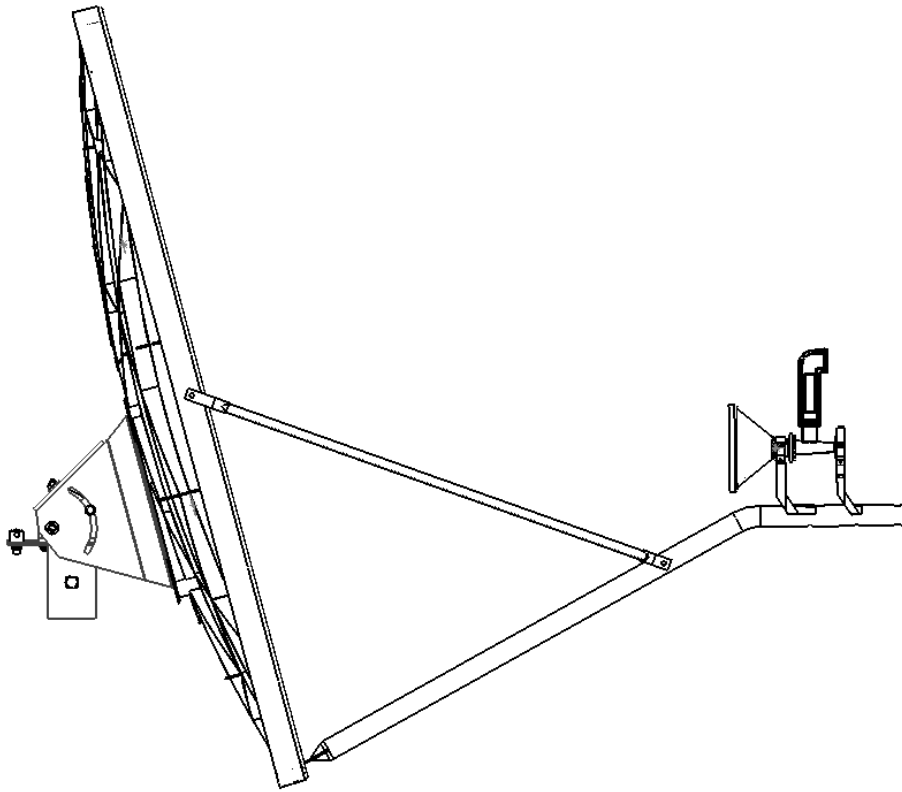

TABLE OF CONTENTS

<u>SECTION</u>	<u>TITLE</u>
I	INTRODUCTION
1.0	GENERAL INFORMATION
1.1	UNPACKING & INSPECTION
1.2	FREIGHT DAMAGE
1.3	MATERIAL MISSING OR DAMAGED
1.4	MECHANICAL INSTALLATION TOOLS
1.5	FOUNDATION INTERFACE
II	ANTENNA SYSTEM ASSEMBLY
2.0	REFLECTOR & SUPPORT ASM PART LIST
2.1	ANTENNA ASSEMBLY
2.2	FEED SUPPORT PART LIST
2.3	FEED SUPPORT ASSEMBLY
III	SATELLITE ALIGNMENT
3.0	ANTENNA POINTING
IV	MAINTENANCE
4.0	MAINTENANCE OVERVIEW
4.1	REFLECTOR
4.2	MOUNT & REFLECTOR SUPPORT
4.3	FEED & FEED SUPPORT

SECTION I INTRODUCTION**1.0 GENERAL INFORMATION**

This manual describes the assembly and installation of CPI's 1.2 meter antenna system. The CPI 1.2 meter is a rugged and reliable mount which will operate in the Ku-Band frequency with high efficiency and at the same time successfully withstand the effects of the environment. The CPI 1.2 meter has an f/d ratio of .8 and an offset angle of 17.30°.

These instructions are listed by sections that cover all areas of assembly and installation. Additional sections are included in the manual to provide information on antenna alignment to the satellite and maintenance.

1.1 UNPACKING AND INSPECTION

The system containers should be unpacked and inspected at the earliest date to insure that all material has been received and is in good condition. A complete packing list for each major component is supplied.

1.2 FREIGHT DAMAGE

Any damage to materials while in transit should be immediately directed to the freight carrier. He will instruct you on matters regarding any freight damage claims.

1.3 MATERIAL – MISSING OR DAMAGED

Any questions regarding missing or damaged materials that are not due to the freight carrier should be directed to CPI's Customer Service Department at:

**CPI Satcom & Antenna Technologies
1700 Cable Drive NE
Conover NC 28613 USA
Phone 770-689-2040
www.cpii.com**

1.4 MECHANICAL INSTALLATION TOOLS

The hardware supplied with this antenna system is U.S. SAE standard size. However, the sizes have been chosen to allow use with compatibly sized metric wrenches as shown in the table below.

HARDWARE SIZE	SAE WRENCH SIZE	METRIC WRENCH SIZE	MAXIMUM REC. TORQUE
5/16" Bolt	1/2"	13 mm	12 ft-lbs (16.27 n-m)
1/4" Bolt	7/16"	11 mm	6 ft-lbs (8.14 n-m)
3/8" Bolt	9/16"	15 mm	22 ft-lbs (29.83 n-m)
1/2" Bolt	3/4"	19 mm	45 ft-lbs (61.02 n-m)
Hi-Lo Screw	7/16"	11 mm	10 ft-lbs (13.56 n-m)

Also recommended for installation:

Compass - graduated to .5°
Adjustable Wrench

1.5 FOUNDATION INTERFACE

The required interface from the foundation to the mount is 2-1/2" schedule 40 pipe (2.88" O.D.). A suggested in-ground foundation is shown in Figure 1.

Also available from CPI, as options, are a kingpost pedestal mount and a non-penetrating mast mount.

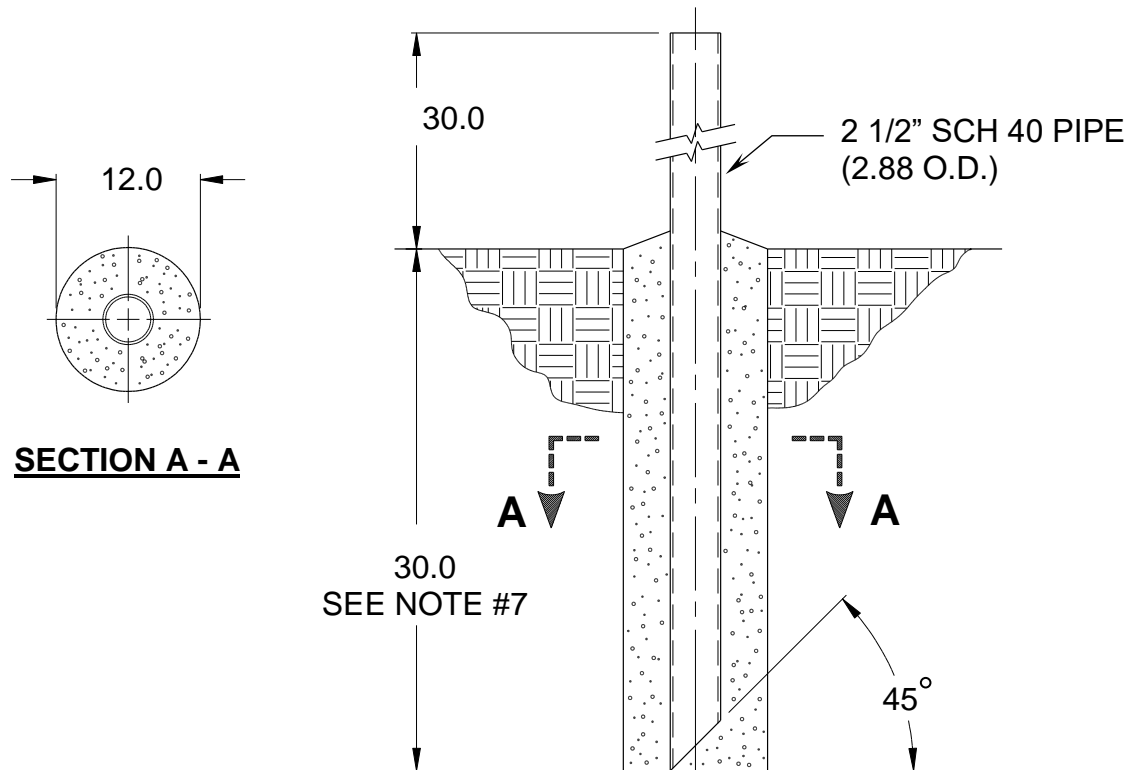
SUGGESTED IN-GROUND FOUNDATION**FIGURE 1.****NOTES:**

1. 2 1/2" schedule 40 pipe should conform to ASTM A53.
2. All concrete should conform to building code standards and have a minimum compressive strength of 3000 PSI at 28 days. (Per ACI-318-77)
3. Soil bearing capacity should be no less than 2000 PSF.
4. Concrete should be poured against undisturbed soil.
5. Allow concrete 24 hours set time before installation of antenna.
6. The antenna should be properly grounded to meet applicable local codes.
7. Minimum depth as shown or extend to local frost line.
8. Foundation meets the design requirements as set forth by the uniform building code. (1982 edition)

(CPI DOES NOT REPRESENT OR WARRANT THAT ANY PARTICULAR DESIGN OR SIZE OF FOUNDATION IS APPROPRIATE FOR ANY LOCALITY OR EARTH STATION INSTALLATION.)

SECTION II REFLECTOR AND SUPPORT ASSEMBLY

REFLECTOR AND SUPPORT ASSEMBLY PART LIST- TABLE 2.0			
ITEM	PART NO.	DESCRIPTION	QTY
1	VARIES	1.2M Reflector	1
2	0185-4332	Az/EI Positioner Assembly	1
3	8319-006	Hi - Lo Screw	4

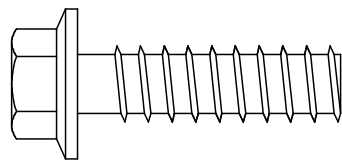

2.1 MOUNT & REFLECTOR ASSEMBLY

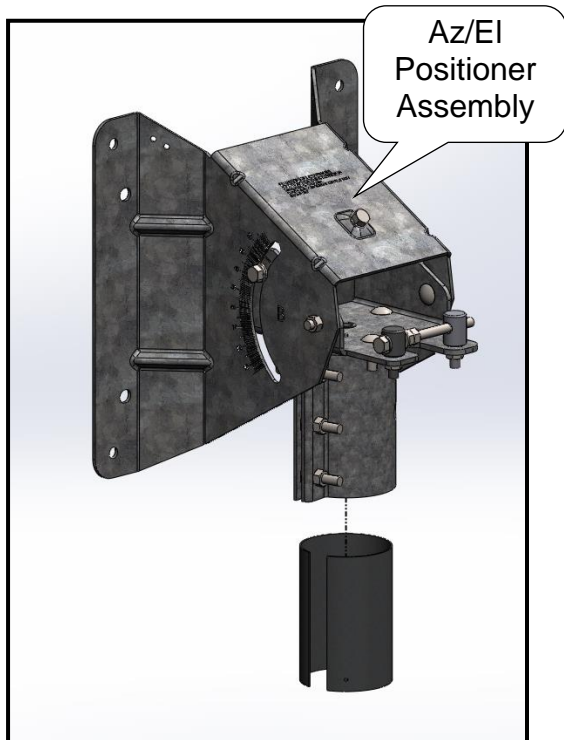

STEP 1.

The Az/EI Positioner Assembly is supplied with a Mast Sleeve for use on 2.88" OD mast pipes.

If the install is on a 2.88" OD mast pipe, the Mast Sleeve should be inserted into the Canister before proceeding to reduce the Canister's inside diameter appropriately.

If the install is on a 3.00" OD (76mm OD) mast pipe, the Mast Sleeve can be omitted and discarded.

CAUTION: During the assembly procedure, the sequence of instructions must be followed. **Do Not Tighten Any Hardware Until Instructed.** Refer to the parts list table and the referenced steps.

STEP 2.

Slip the Az/EI Positioner (item 2) onto the mast pipe as shown.

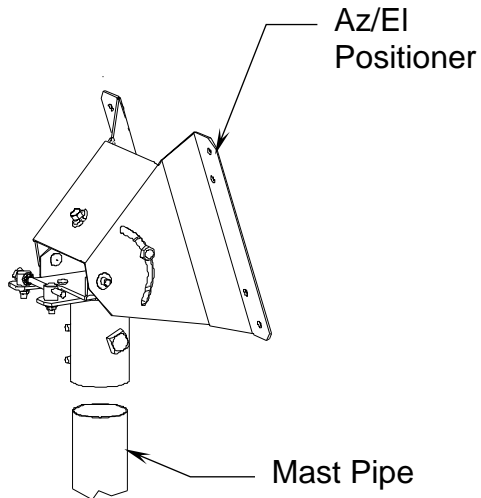

STEP 3.

Place reflector onto Az/EI Positioner Assembly and secure using the Hi-lo screws provided.

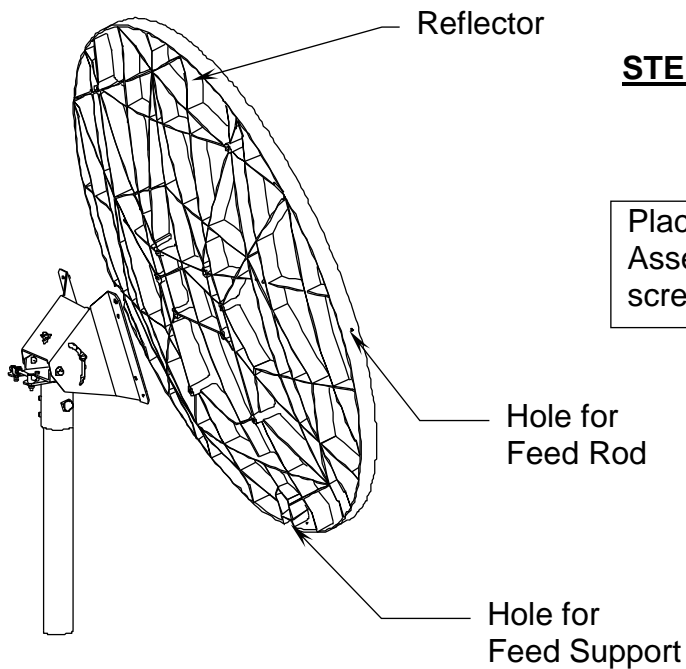

2.2 FEED SUPPORT ASSEMBLY

NOTE: These instructions are intended as a general reference for feed support assembly. If your antenna system has specific feed support installation instructions, then refer to them at this time.

CAUTION: During the assembly procedure, the sequence of instructions must be followed. **DO NOT TIGHTEN ANY HARDWARE UNTIL INSTRUCTED.** Refer to the feed support parts list and steps.

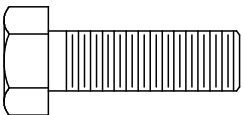
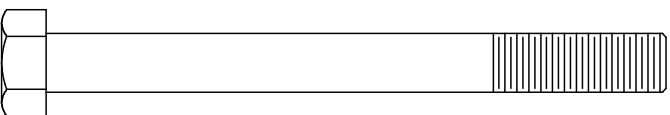
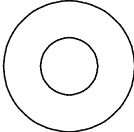
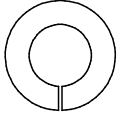
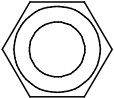
FEED SUPPORT PARTS LIST - TABLE 2.2			
ITEM NO.	PART NO.	DESCRIPTION	QTY
1	VARIES	Feed Rod	2
2	VARIES	Feed Support Tube	1
3	8031-008	5 / 16" x 1.00" Bolt 	3
4	8031-026	5 / 16" x 3.25" Bolt 	1
5	8201-041	5 / 16" Flatwasher 	8
6	8202-041	5 / 16" Lock Washer 	4
7	8101-009	5 / 16" Hex Nut 	4

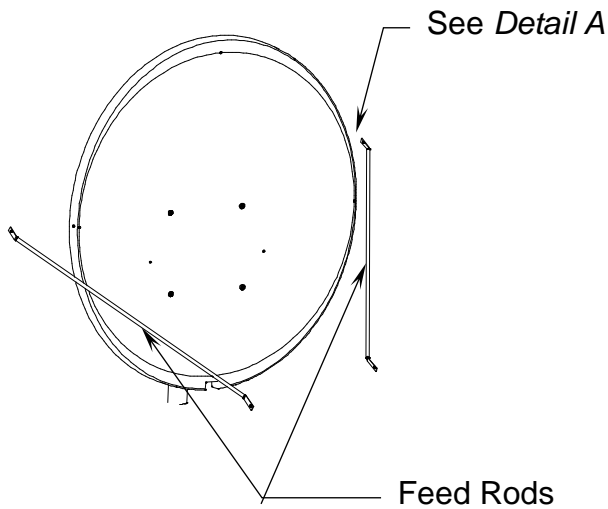

STEP 1.

- A) Attach feed rods to reflector with (items: 3, 6, 7 and with [2] of (item 5).

NOTE: The 2.00" flat end of the feed rod mounts to the outside rim of the reflector

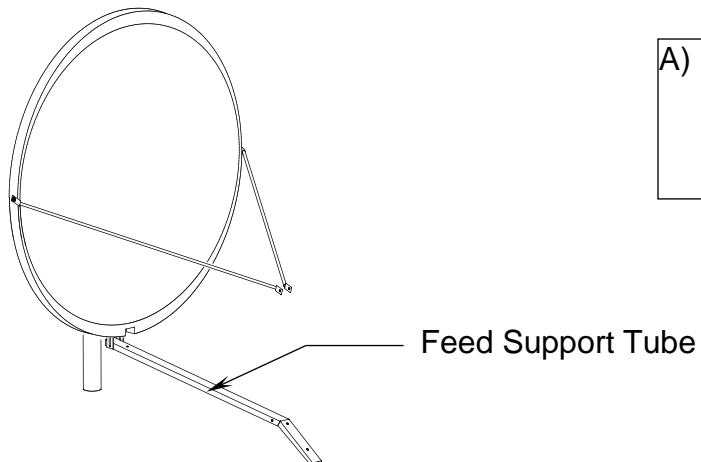

STEP 2.

- A) Attach feed support tube to the reflector with (items: 3, 6, 7) and with [2] of (item 5).

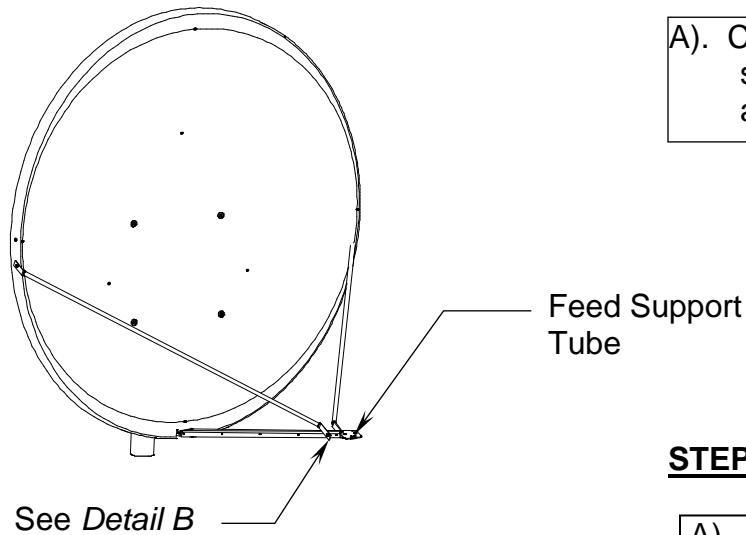

STEP 3.

A). Connect the feed rods to the feed support tube with (items: 4, 6, 7) and with [2] of (item 5).

STEP 4.

A). Tighten the hardware at the reflector rim snugly (Detail A).

B). Tighten the hardware connecting the feed rods to the feed support tube (Detail B).

C). Tighten the hardware connecting the feed support tube to the reflector.

D). Refer to separate instructions for the specific feed/ODU assembly to feed support.

DETAIL A

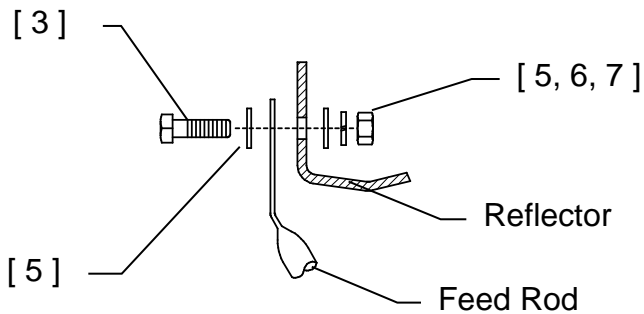

DETAIL B

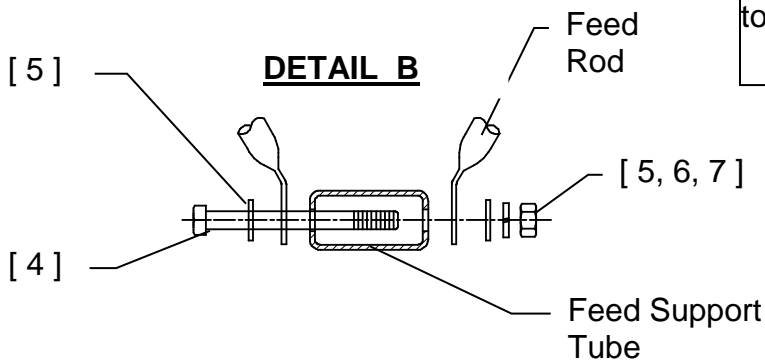

SECTION III ANTENNA POINTING

3.0 ANTENNA POINTING

The 1.2 meter reflector contains a 17.3° elevation offset look angle. Therefore, when the reflector aperture is perpendicular to the ground, the antenna is actually looking 17.3° in elevation. Refer to Figure 2.

Note: The following alignment procedure is intended only as a general reference guide for this antenna. For proper antenna performance, accurate alignment is critical. Therefore, it is recommended that your own detailed procedure be used or contact CPI's Technical Support Department for additional recommendations.

STEP 1: BEFORE ADJUSTING ELEVATION LOOSEN THE HARDWARE ON BOTH SIDES OF THE POSITIONER, REFER TO FIGURE 2 FOR LOCATION. Adjust the reflector up or down in elevation by turning the 5/16" Bolt at the az/el positioner until the desired elevation is read on the side of the positioner. This scale is used for nominal readings and is accurate to ± 2 degrees. ***Note: Elevation rod is for adjustment only, it is not intended to be part of the structural integrity of the assembly, tightening the elevation rod is not necessary.*** Snug the hardware at the side of the positioner.

STEP 2: Azimuth Adjustment: With the electronics set to acquire the satellite, rotate the antenna in azimuth until the satellite is found. Tighten the canister hardware at this time.

STEP 3: Fine azimuth adjustment is achieved by **loosening the three hex nuts inside the Az/el positioner and the nut under the azimuth pivot** then turn the single hex bolt at the back of the positioner in either direction. ***Note: Azimuth rod is for adjustment only, it is not intended to be part of the structural integrity of the assembly, tightening the azimuth rod is not necessary.***

STEP 4: Peak the antenna signal by fine adjustments made in both azimuth and elevation until the optimum signal is achieved.

STEP 5: Tighten all hardware used for adjustment.

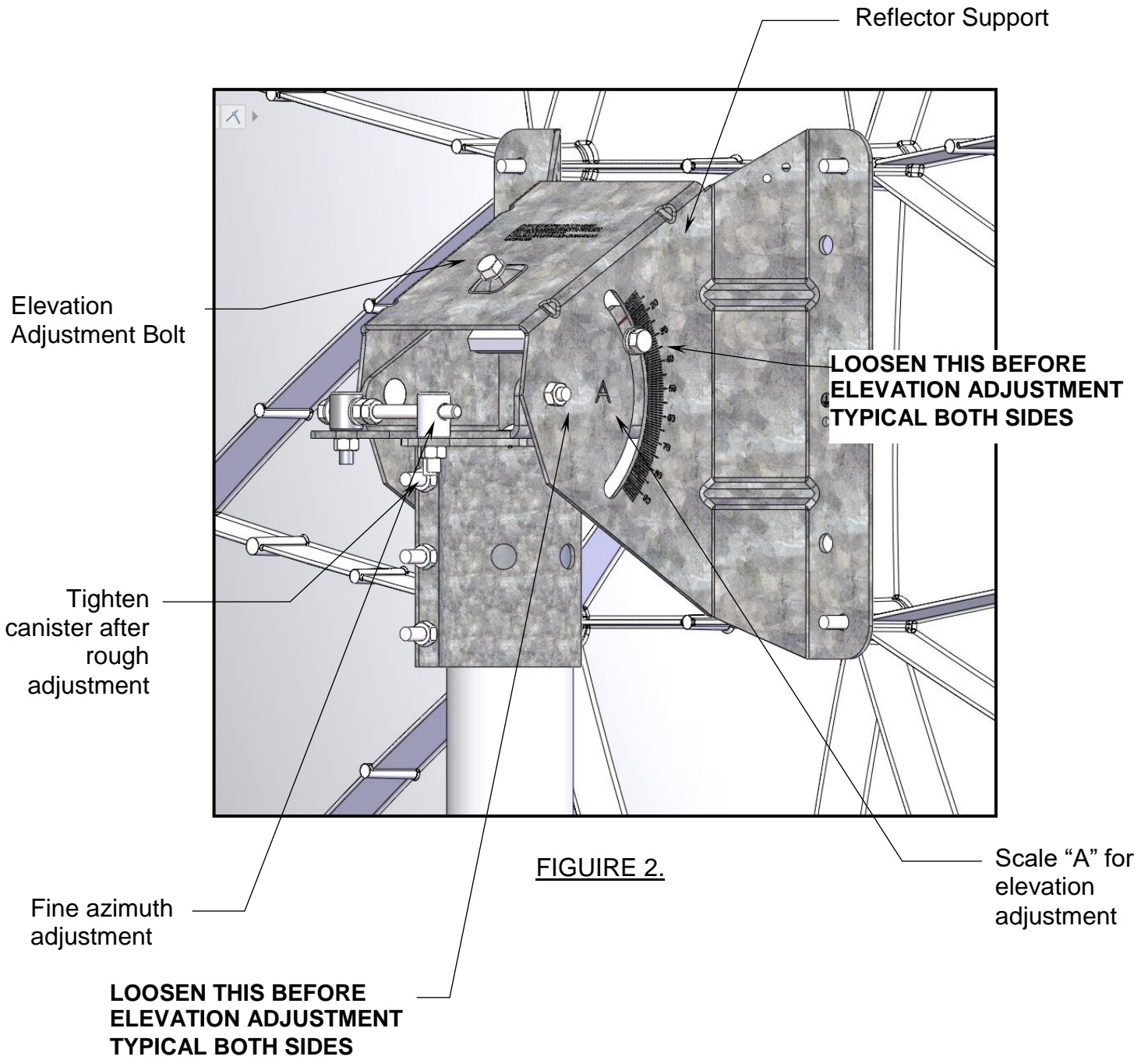

FIGURE 2.

SECTION IV MAINTENANCE**4.0 MAINTENANCE OVERVIEW**

After installation, the antenna requires only periodic inspection. It is anticipated that maintenance, if required, will be minimal and easily handled by a local or in-house maintenance staff.

4.1 REFLECTOR

CPI's reflector does not require any maintenance. The composite construction of the reflector is virtually impervious to any damages that could be caused by weather or atmospheric conditions. It is only necessary to inspect for any physical damage done by vandalism or very severe weather conditions.

Should any damage be detected to a portion of the reflector, contact the Customer Service Department at CPI for recommendations involving reflector repair.

4.2 MOUNT AND REFLECTOR SUPPORT STRUCTURE

The mount and reflector support structure supplied with this antenna is of steel construction and has a galvanized finish.

If there are any signs of structural failure, the mount members that are damaged should be repaired or replaced.

4.3 FEED AND FEED SUPPORT

The feed support and feed rods should be inspected to insure that all hardware is secure. The feed/radio mounting bolts should be tight.

The feed horn window should be inspected to insure that it is intact so that no moisture can collect inside the feed horn.